

DW® Universal HD over Coax® ultra low-profile vandal dome cameras

DWC-V7253



**UNIVERSAL
HD COAX**

WHAT'S IN THE BOX

Mount bolts and nuts		1 set	Mounting template		1
Star Wrench (T-20)		1	Quick set up Guide		1
Screws and plastic anchors -2pcs		1 set	Test video cable		1
DC plug cable		1			

NOTE: Download all your support materials and tools in one place

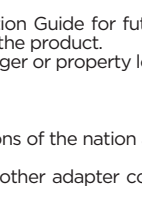
- Go to: <http://www.digital-watchdog.com/resources>
- Search your product by entering the part number in the **'Search by Product'** search bar. Results for applicable part numbers will populate automatically based on the part number you enter.
- Click **'Search'**. All supported materials, including manuals and quick start guide (QSGs) will appear in the results.

Attention: This document is intended to serve as a quick reference for initial set-up. It is recommended that the user read the entire instruction manual for complete and proper installation and usage.

SAFETY AND WARNING INFORMATION

Read through this Installation Guide carefully before installing the product. Keep the Installation Guide for future reference. See the user manual for more information on the proper installation, use and care of the product. These instructions are intended to ensure that users can use the product correctly to avoid danger or property loss. Warnings: Serious injury or death may occur if any of the warnings are neglected. Cautions: Injury or equipment damage may occur if any of the cautions are neglected.

WARNING

- In the use of the product, you must be strict compliance with the electrical safety regulations of the nation and region. When the product is mounted on a wall or ceiling, the device shall be firmly fixed.
- Be sure to use only the standard adapter specified in the specification sheet. Using any other adapter could cause fire, electrical shock, or damage to the product.
- Make sure the power supply voltage is correct before using the camera.
- Incorrectly connecting the power supply or replacing the battery may cause an explosion, fire, electric shock, or damage to the product.
- Do not connect multiple cameras to a single adapter. Exceeding the capacity may cause excessive heat generation or fire.
- Securely plug the power cord into the power source. An insecure connection may cause a fire.
- When installing the camera, fasten it securely and firmly. A falling camera may cause personal injury.
- Do not install in a location subject to elevated temperature, low temperature, or high humidity. Doing so may cause fire or electric shock.
- Do not place conductive objects (e.g. screwdrivers, coins, metal items, etc.) or containers filled with water on top of the camera. Doing so may cause personal injury due to fire, electric shock, or falling objects.
- Do not install in humid, dusty, or sooty locations. Doing so may cause fire or electric shock.
- Do not install near any heat sources such as radiators, heat registers, or other products (including amplifiers) that produce heat.
- Keep out of direct sunlight and heat radiation sources. It may cause a fire.
- If any unusual smells or smoke come from the unit, stop using the product at once. Immediately disconnect the power source and contact the service center. Continued use in such a condition may cause fire or electric shock.
- If this product does not operate normally, contact the nearest service center. Never disassemble or change this product in any way.
- When cleaning the product, do not spray water directly onto parts of the product. Doing so may cause fire or electric shock.

CAUTION

- Use proper safety gear when installing and wiring the product.
- Do not drop objects on the product or apply strong shock to it. Keep away from a location subject to excessive vibration or magnetic interference.
- Do not use this product near water.
- The product shall not be exposed to dripping or splashing and no objects filled with liquids, such as vases, shall be placed on the product.
- Avoid aiming the camera directly towards extremely bright objects such as the sun, as this may damage the image sensor.
- The Main plug is used as a disconnect device and shall stay readily operable at any time.
- Remove the power adapter from the outlet when there is lightning. Neglecting to do so may cause fire or damage to the product.
- Do not block any ventilation openings. Install following the manufacturer's instructions.
- Do not place conductive objects (e.g. screwdrivers, coins, metal items, etc.) or containers filled with water on top of the camera. Doing so may cause personal injury due to fire, electric shock, or falling objects.
- A polarized or grounding-type plug is recommended for this product. A polarized plug has two blades with one wider than the other. A grounding-type plug has two blades and a third grounding prong. If the provided plug does not fit into your outlet, consult an electrician for replacement.
- Protect the power cord from being walked on or pinched particularly at plugs, convenience receptacles, and the point where they exit from the product.
- If any laser equipment is used near the product, make sure the surface of the sensor is not exposed to the laser beam as that may damage the sensor module.
- If you want to move the already installed product, be sure to turn off the power and then move or reinstall it.
- Proper configuration of all passwords and other security settings is the responsibility of the installer and/or end-user.
- If cleaning is necessary, please use a clean cloth to wipe it gently. If the device will not be used for a long time, please cover the lens cap to protect the device from dirt.
- Do not touch the camera's lens or sensor module with fingers. If cleaning is necessary, please use a clean cloth to wipe it gently. If the device will not be used for a long time, please cover the lens cap to protect the device from dirt.
- Use only attachments/accessories specified by the manufacturer.
- Always use hardware (e.g. screws, anchors, bolts, locking nuts, etc.) compatible with the mounting surface and of sufficient length and construction to ensure a secure mount.
- Use only with cart, stand, tripod, bracket, or table specified by the manufacturer, or sold with the product.
- Unplug this product when a cart is used. Use caution when moving the cart/product combination to avoid injury from tip-over.
- Refer all servicing to qualified service personnel. Servicing is needed when the product has been damaged in any way, such as power supply cord or plug is damaged, liquid has been spilled or objects have fallen into the product, the product has been exposed to rain or moisture, does not operate normally, or has been dropped.

STEP 1 - PREPARING TO MOUNT THE CAMERA

- Detach the camera's dome cover by loosening the three (3) screws on the dome using the included torque wrench.
- This product is intended to be supplied by a UL Listed Power Supply Unit marked "Class 2" or "LPS" or "PS2" and rated 12 Vdc, 0.16A min.

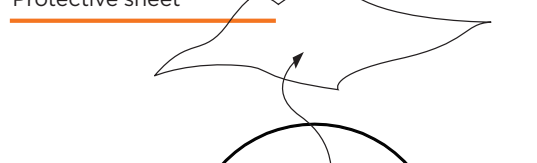

STEP 2 - POWERING THE CAMERA

Pass the wires through the mount bracket and make all necessary connections. Connect the BNC cable and power cables to the camera.

Power requirements	Power consumption
12VDC ONLY! CAUTION! The camera supports DC power supply only	DC12V: 1.92W

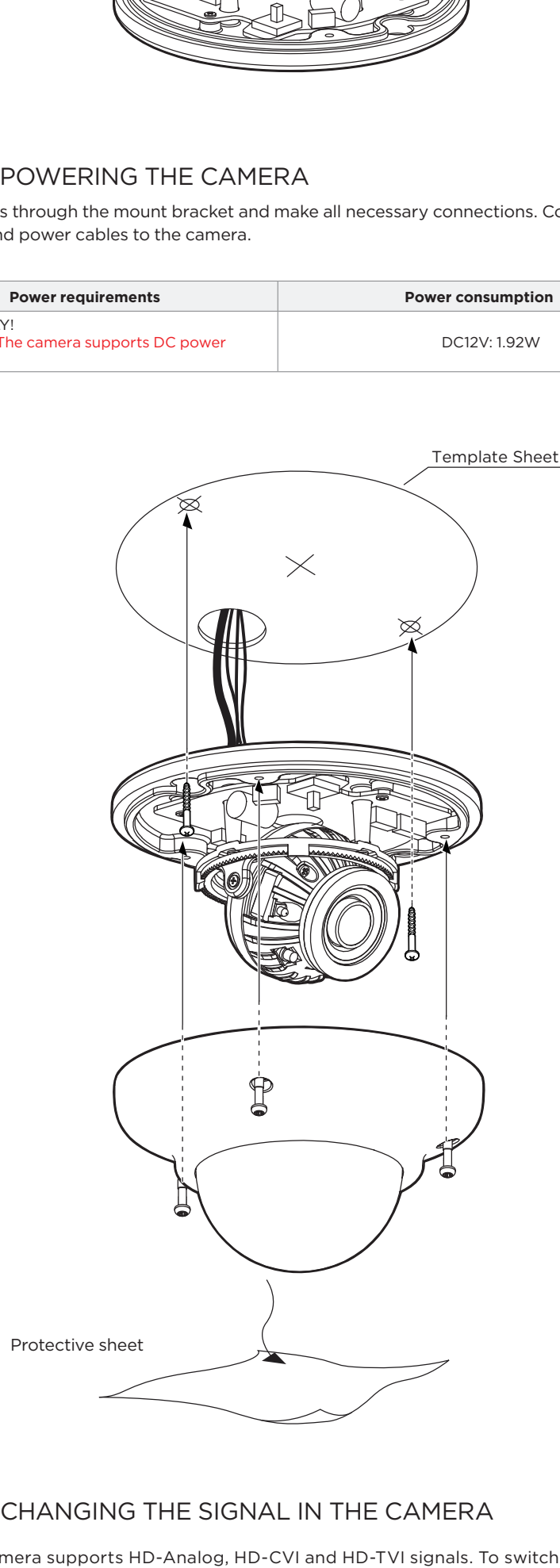

STEP 3 - CHANGING THE SIGNAL IN THE CAMERA

- The camera supports HD-Analog, HD-CVI and HD-TVI signals. To switch between the signals:
 - Remove the camera's dome to access the joystick and OSD control on the base of the camera.
 - Use the OSD Switch to switch the camera's signal.
 - To switch the camera to HD-TVI mode, press OSD joystick to the left for 5 seconds.
 - To switch the camera to HD-Analog mode, press OSD joystick to the right for 5 seconds.
 - To switch the camera to CVBS mode, press OSD joystick up for 5 seconds.
 - To switch the camera to HD-CVI mode, press OSD joystick down for 5 seconds.

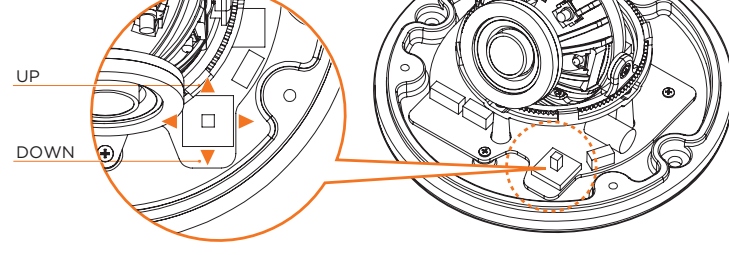
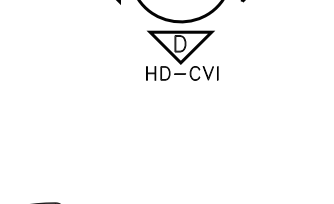

STEP 4 - INSTALLING THE CAMERA

- Once all cables have been connected, use the screws included with the camera to properly mount and secure the camera to the mounting surface.
- Adjust the camera's pan, tilt and position to achieve the desired view. The cameras' max angles are:

Pan: 0° - 360°

Tilt: 0° - 70°

Rotation: 0° - 360°

To adjust the camera's pan and tilt position, the pan/tilt stopper screw must be loosened. Locate the screw at the base of the camera's lens. Loosen the screw slightly to allow the camera module to move as needed. Using force to rotate the camera's module without loosening the screw may damage the camera. To loosen the screw, use a Philips head screwdriver and twist the screw counterclockwise. To tighten the screw back after adjusting the camera module's pan and tilt, twist the screw clockwise.

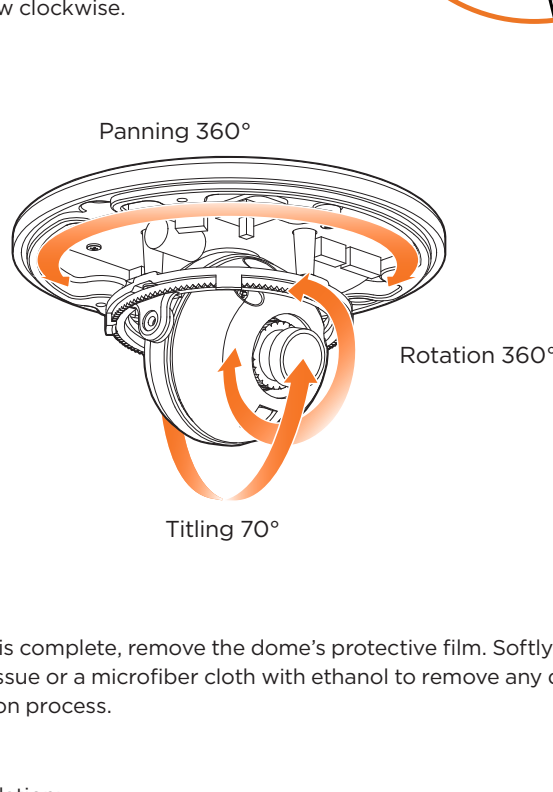
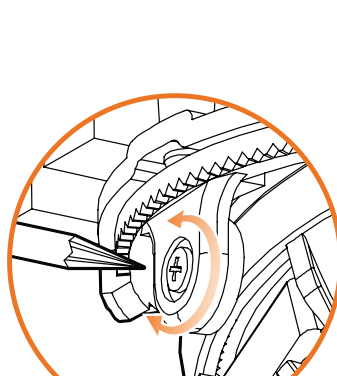

- When the installation is complete, remove the dome's protective film. Softly wipe the dome/lens cover with lens tissue or a microfiber cloth with ethanol to remove any dust or smudges left from the installation process.

For a bolt and nut installation:

- Using the bolt and nut mounting template, mark and drill the necessary holes in the mounting surface.
- Pass wires through and make all connections (see STEP 2 for more information).
- Secure the two long mounting screws to the camera's base.
- Mount the camera to the mounting surface by using the 2 mounting nuts.
- Rotate the locking discs over the screws until the camera is held tightly to the mounting surface.

