

MEGAPIX[®]

IP Cameras

DWC-MV45WIATW

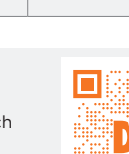
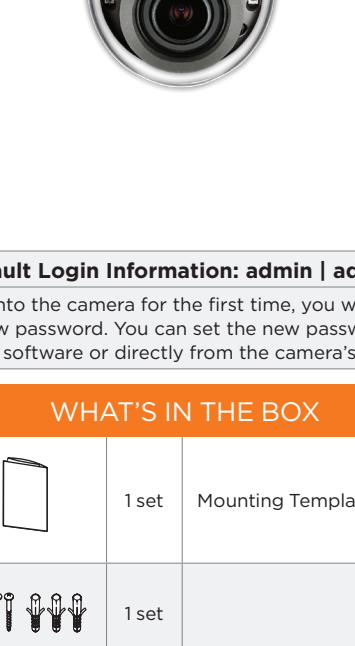

Default Login Information: admin | admin

When logging into the camera for the first time, you will be prompted to set up a new password. You can set the new password using the DW[®] IP Finder[™] software or directly from the camera's browser menu.

WHAT'S IN THE BOX

Quick Setup and Installation Guides		1 set	Mounting Template		1
Screws and Plastic Anchors - 3pcs		1 set			

NOTE: Download all your support materials and tools in one place

- Go to: <http://www.digital-watchdog.com/resources>
- Search your product by entering the part number in the 'Search by Product' search bar. Results for applicable part numbers will populate automatically based on the part number you enter.
- Click 'Search': All supported materials, including manuals and quick start guide (QSGs) will appear in the results.

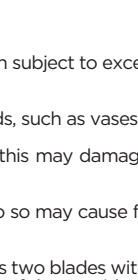

Attention: This document is intended to serve as a quick reference for the initial set-up. It is recommended that the user read the entire instruction manual for complete and proper installation and usage.

SAFETY AND WARNING INFORMATION

Read through this Installation Guide carefully before installing the product. Keep the Installation Guide for future reference. See the user manual for more information on the proper installation, use and care of the product. These instructions are intended to ensure that users can use the product correctly to avoid danger or property loss. Warnings: Serious injury or death may occur if any of the warnings are neglected. Cautions: Injury or equipment damage may occur if any of the cautions are neglected.

WARNING

- In the use of the product, you must be strict compliance with the electrical safety regulations of the nation and the region. When the product is mounted on a wall or ceiling, the device shall be firmly fixed.
- Be sure to use only the standard adapter specified in the specification sheet. Using any other adapter could cause fire, electrical shock, or damage to the product.
- Make sure the power supply voltage is correct before using the camera.
- Incorrectly connecting the power supply or replacing the battery may cause an explosion, fire, electric shock, or damage to the product.
- Do not connect multiple cameras to a single adapter. Exceeding the capacity may cause excessive heat generation or fire.
- Do not plug the power cord into the power source. An insecure connection may cause a fire.
- When installing the camera, fasten it securely and firmly. A falling camera may cause personal injury.
- Do not install in a location subject to elevated temperature, low temperature, or high humidity. Doing so may cause fire or electric shock.
- Do not install near any heat sources such as radiators, heat registers, or other products (including amplifiers) that produce heat.
- Keep out of direct sunlight and heat radiation sources. It may cause a fire.
- If any unusual smells or smoke come from the unit, stop using the product at once. Immediately disconnect the power source and contact the service center. Continued use in such a condition may cause fire or electric shock.
- If this product does not operate normally, contact the nearest service center. Never disassemble or change this product in any way.
- When cleaning the product, do not spray water directly onto parts of the product. Doing so may cause fire or electric shock.

CAUTION

- Use proper safety gear when installing and wiring the product.
- Do not drop objects on the product or apply strong shock to it. Keep away from a location subject to excessive vibration or magnetic interference.
- Do not use this product near water.
- The product shall not be exposed to dripping or splashing and no objects filled with liquids, such as vases, shall be placed on the product.
- Avoid aiming the camera directly towards extremely bright objects such as the sun, as this may damage the image sensor.
- Securely plug the lens cap as a disconnect device and shall stay readily operable at any time.
- Remove the power adapter from the outlet when there is lightning. Neglecting to do so may cause fire or damage to the product.
- Do not block any ventilation openings. Install following the manufacturer's instructions.
- Always use hardware (e.g. screws, anchors, bolts, locking nuts, etc.) compatible with the mounting surface and of sufficient length and construction to ensure a secure mount.
- Use only with cart, stand, tripod, bracket, or table specified by the manufacturer, or sold with the product.
- Unplug this product when a cart is used. Use caution when moving the cart/product combination to avoid injury from tip-over.
- Refer all servicing to qualified service personnel. Servicing is needed when the product has been damaged in any way, such as power supply cord or plug is damaged, liquid has been spilled or objects have fallen into the product, the product has been exposed to rain or moisture, does not operate normally, or has been dropped.

STEP 1 - PREPARING TO MOUNT THE CAMERA

- The mounting surface must bear five times the weight of your camera.
- Do not let the cables get caught in improper places or the electric line cover to be damaged.
- CAUTION:** These servicing instructions are for use by a qualified service personnel only. To reduce the risk of electric shock do not perform any servicing other than that contained in the operating instructions unless you are qualified to do so.
- This product is intended to be supplied by a UL Listed Power Supply Unit marked "Class 2" or "LPS" or "PS2" and rated 12 Vdc, 0.69A min.
- The wired LAN hub providing power over the Ethernet (PoE) in the product with IEEE 802-3af shall be a UL Listed device with the output evaluated as a Limited Power Source as defined in UL60950-1 or PS2 as defined in UL62368-1.
- Unit is intended for installation in a Network Environment 0 as defined in IEC TR 62102. As such, associated Ethernet wiring shall be limited to inside the building.
- From the installation, detach the camera module from the junction box. Use the Star Screwdriver included to loosen the three screws at the base of the camera module.
- Install the moisture packet in the base of the camera module.
 - Remove the moisture absorber from the packaging.
 - Cut the card and folder along the dotted line.
 - Place the moisture absorber under the camera's lens module.

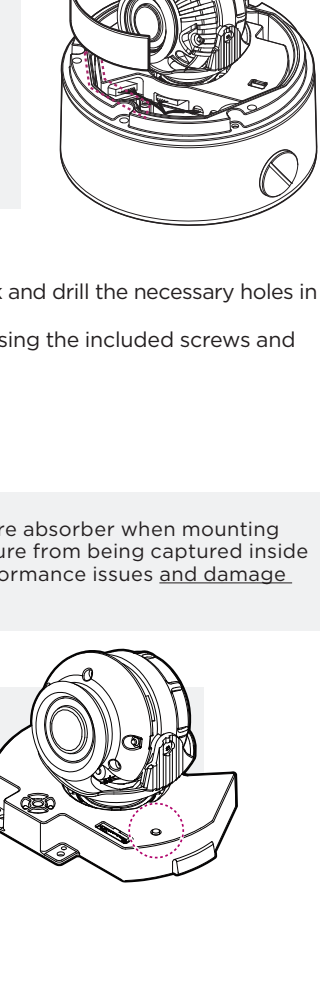

NOTE: The camera will generate enough heat to dry moisture during operation. In most cases it will not need the moisture absorber for more than the first day. In cases where the camera can experience a moisture issue, users must keep the moisture absorber in the camera. The moisture absorber has an approximately 6-month life cycle, varying depending on the environment.

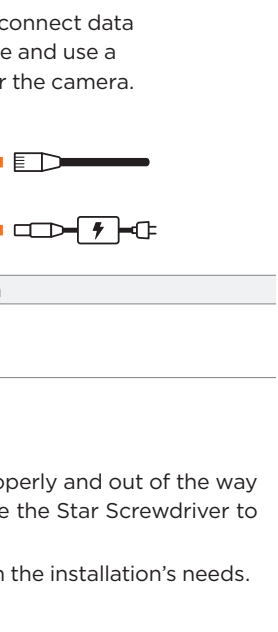

- Using the mounting template sheet or the camera itself, mark and drill the necessary holes in the wall or ceiling.
- Secure the camera's junction box to the mounting surface using the included screws and anchors.

WARNING: It is highly recommended that you install the moisture absorber when mounting the camera. The moisture absorber prevents moisture from being captured inside the camera's housing, which may cause image performance issues and damage the camera.

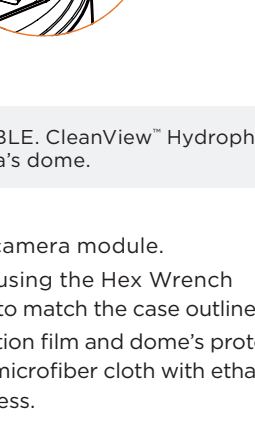

Resetting the camera: Press the button for five (5) seconds to initiate a camera-wide reset of all the settings, including network settings.

STEP 2 - POWERING THE CAMERA

- Pass the wires through and make all necessary connections.
- Use a PoE Injector (required. Sold separately) to connect data and power to the camera using a single Ethernet cable.
- OR
- Use non-PoE Switch to connect data using an Ethernet cable and use a power adapter to power the camera.

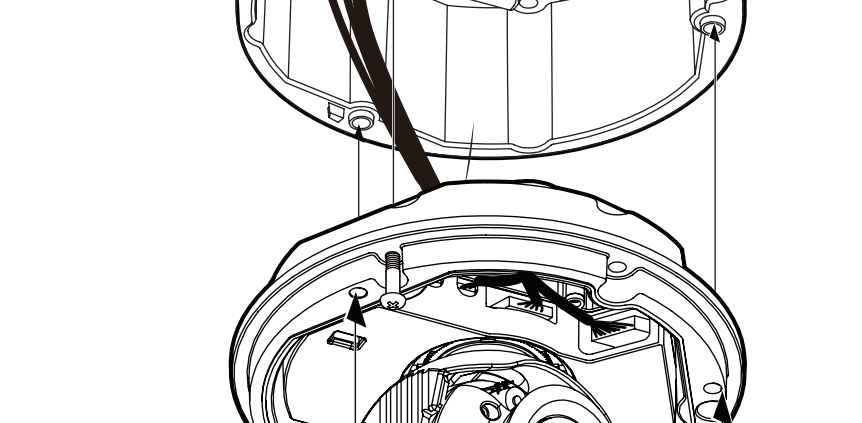

Power requirements	Power consumption
DC12V, PoE (IEEE 802.3af class 3). Adapter not included.	DC12V: max 8.3W PoE: max 10.5W

STEP 3 - INSTALLING THE CAMERA

- Once all cables are connected, make sure they are positioned properly and out of the way (see STEP 4). Attach the camera module to the junction box. Use the Star Screwdriver to secure the camera in place.
- Adjust the camera's tilt and angle using its 3-axis gimbal to match the installation's needs.

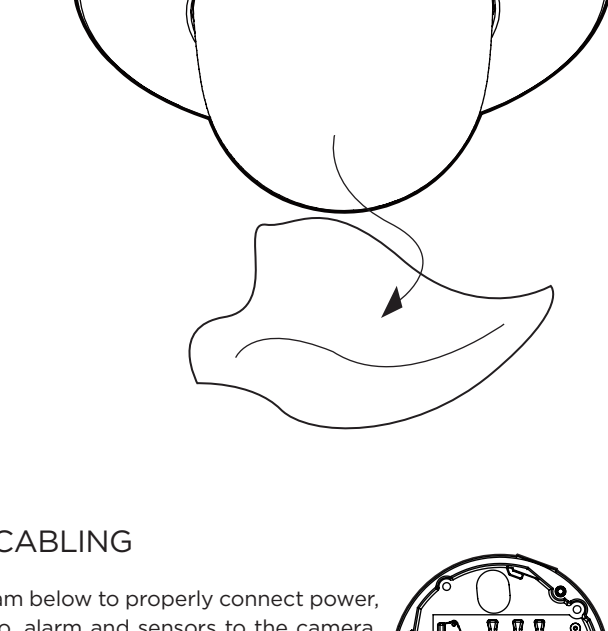

WARNING DO NOT TOUCH THE SURFACE OF THE BUBBLE. CleanView[™] Hydrophobic Dome Coating has been applied to the camera's dome.

- Remove the protective film between the dome and the camera module.
- Attach the camera's dome cover to the camera module using the Hex Wrench included. Be sure to assemble the dome and bottom case to match the case outline.
- After the installation is complete, remove the inner protection film and dome's protective film. Softly wipe the dome/lens cover with lens tissue or a microfiber cloth with ethanol to remove any dust or smudges left from the installation process.

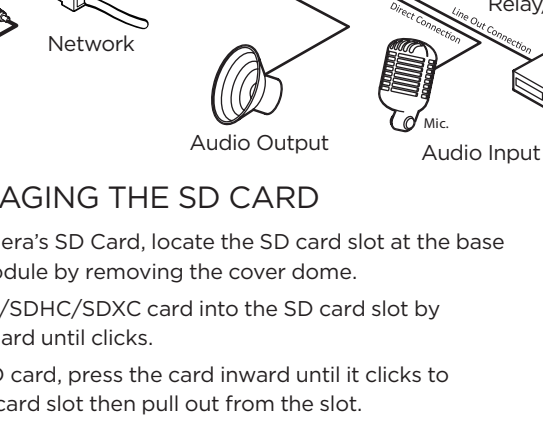

STEP 4 - CABLING

Use the diagram below to properly connect power, network, audio, alarm and sensors to the camera. Once all cables are connected, organize the cable outlets in the cable holder at the base of the junction box. This keeps the cables from getting caught between the camera module and junction box.

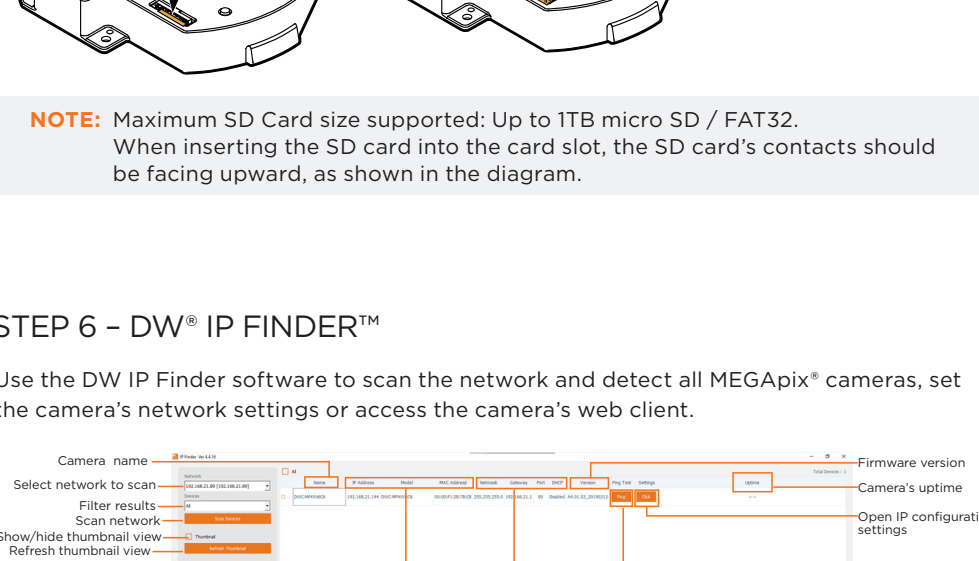

STEP 5 - MANAGING THE SD CARD

- To install the camera's SD Card, locate the SD card slot at the base of the camera module by removing the cover dome.
- Insert class 10 SD/SDHC/SDXC card into the SD card slot by pressing the SD card until it clicks.
- To remove the SD card, press the card inward until it clicks to release from the card slot then pull out from the slot.

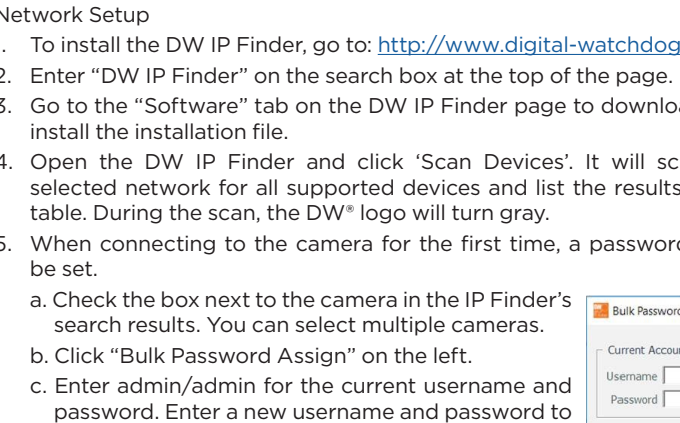

NOTE: Maximum SD Card size supported: Up to 1TB micro SD / FAT32. When inserting the SD card into the card slot, the SD card's contacts should be facing upward, as shown in the diagram.

STEP 6 - DW[®] IP FINDER[™]

Use the DW IP Finder software to scan the network and detect all MEGAPIX[®] cameras, set the camera's network settings or access the camera's web client.

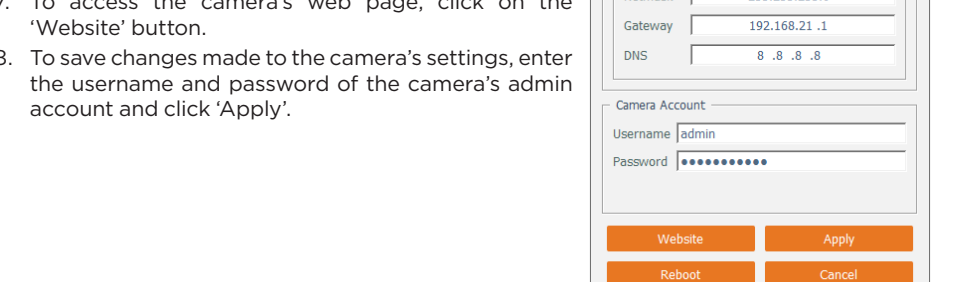

- Network Setup
 - To install the DW IP Finder, go to: <http://www.digital-watchdog.com>
 - Enter "DW IP Finder" on the search box at the top of the page.
 - Go to the "Software" tab on the DW IP Finder page to download and install the installation file.
 - Open the DW IP Finder and click "Scan Devices". It will scan the selected network for all supported devices and list the results in the table. During the scan, the DW[®] logo will turn gray.
 - When connecting to the camera for the first time, a password must be set.
 - Check the box next to the camera in the IP Finder's search results. You can select multiple cameras.
 - Click "Bulk Password Assign" on the left.
 - Enter admin/admin for the current username and password. Enter a new username and password to the right.

Passwords must have a minimum of eight (8) characters and at least four (4) combinations of uppercase and lowercase letters, numbers and special characters. Passwords cannot contain the user ID.
 - Click "change" to apply all changes.

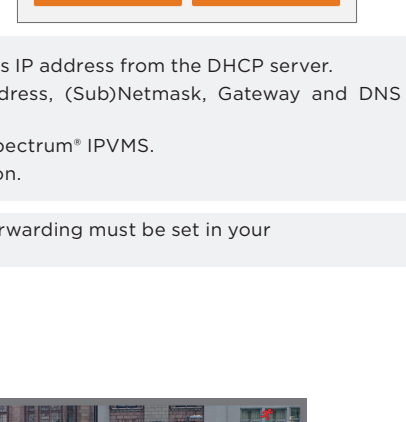

- Select a camera from the list by double-clicking on the camera's name or clicking on the 'Click' button. The pop-up window will show the camera's current network settings. Admin users can adjust the settings as needed. The camera's network settings are set to DHCP by default.
- To access the camera's web page, click on the "Website" button.
- To save changes made to the camera's settings, enter the username and password of the camera's admin account and click 'Apply'.

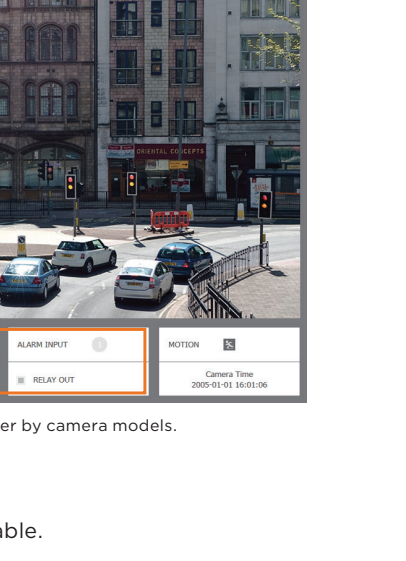

- Select "DHCP" for the camera to automatically receive its IP address from the DHCP server.
- Select "Static" to manually enter the camera's IP address, (Sub)Netmask, Gateway and DNS information.
- The camera's IP must be set to static if connecting to Spectrum[®] IPVMS.
- Contact your network administrator for more information.

To access the camera from an external network, port forwarding must be set in your network's router.

STEP 7 - WEB VIEWER

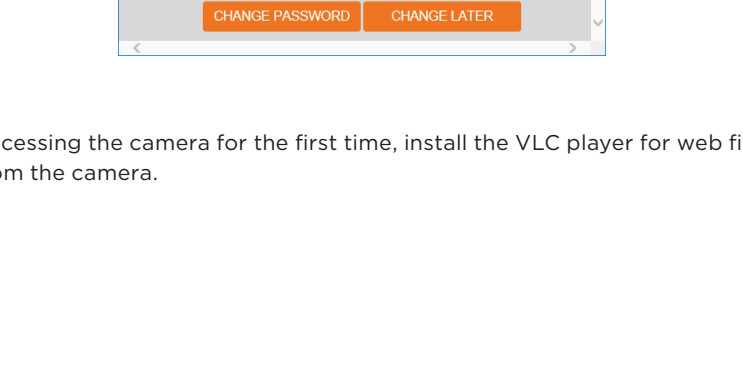

*The GUI display may differ by camera models.

- Find the camera using the DW IP Finder.
- Double-click on the camera's view in the results table.
- Press the "View Camera Website".
- Enter the camera's username and password you setup in the DW IP Finder. If you did not setup a new username and password, a message will direct you to setup a new password for the camera to view the video.

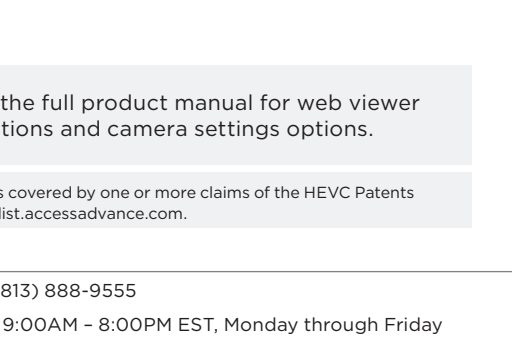

When accessing the camera for the first time, install the VLC player for web files to view video from the camera.

NOTE: Please see the full product manual for web viewer setup, functions and camera settings options.

